

Why Do You Keep Your
M16 Rifle Clean

Inside and Out
and Lubed
with LSA?



BECAUSE-
YOU BET YOUR LIFE ON IT!!



CLEAN AND
LUBE



The M16A1 Rifle

OPERATION AND PREVENTIVE MAINTENANCE



DO ME A
FAVOR, TIGER...
DO A QUICK
BEFORE-
OPERATIONS
CHECK ON
YOUR RIFLE
BEFORE WE
COUNTER ATTACK.

HEY, SARGE!
GET THIS COPY
TO THE MAN
WITH THE RIFLE

Will Eisner

You want to know her inside out, every contour and curve, every need and whim, what makes her tick.

No better time to get all-over acquainted than when you disassemble/assemble her for servicing.

Take it easy, no force . . . you could damage your chances in a showdown.

Eye-check the parts as you handle 'em. Get to know 'em by name and make sure they're OK for action.

Lay the parts down on a clean tarp or something in left-to-right order so that you won't lose any. Know how far you can strip, and stop right there.

OK, by the numbers now, start stripping—but gently. The orange numbers are for taking it apart; the black for putting it together.

GETTIN'
TO KNOW
ALL ABOUT
YOU . . ."

HOW TO

STRIP

YOUR BABY

COMES A
FIREFIGHT-
YOUR M16A1
RIFLE'S YOUR
DEAREST NEXT
O'SKIN-BAR
NONE!



DISASSEMBLY		ASSEMBLY
1 Remove magazine.		Insert and seat. 16
2 Open bolt, check chamber for ammo.		
3 Press takedown pin to right with cartridge or finger.		Be sure selector lever's on SAFE or SEMI-AUTO before closing upper and lower receivers. 15
4 Pull back on charging handle and bolt carrier assembly.		Shove 'em in in reverse order. 14

DISASSEMBLY		ASSEMBLY
5 Take out the bolt and carrier assembly.		Put 'em back the same way, but be sure the bolt's unlocked. 13
6 Remove the charging handle.		Hook the handle in, then shove it in. 12
7 Push out the firing pin retaining pin.		Insert firing pin retaining pin, like so: Put the firing pin forward. The retaining pin goes in back of the large shoulder of the firing pin. Turn the retaining pin as you install it. 11
8 Put bolt in LOCK position. Heed this: Never open or close the split end of the retaining pin.		
9 Remove the firing pin.		Install firing pin by dropping it in the hole. 10
10 Take out bolt cam pin, give it a 1/4 (90 degree) turn.		After you install the cam pin, give it a 1/4 (90 degree) turn. 9
11 Pull the bolt out of the carrier assembly.		When you install the bolt, be sure you stagger the ring gaps to prevent gas leakage. 8
12 Use the firing pin to push out the extractor pin.		Insert the extractor pin. 7

DISASSEMBLY		ASSEMBLY	
13 Remove extractor and spring assembly for cleaning only. Remember not to lose, damage or separate them.		If you goofed and separated the spring from the extractor, insert the large end of the spring in the extractor and seat it.	6
14 Remove the sling.		Install the sling.	5
15 Take handguards off by first pulling down on the slip ring.		Install by first putting handguards in place, then push up on slip ring.	4
16 Use the firing pin to release the receiver pivot pin.		Engage the receiver pivot pin.	3
17 Separate the upper and lower receivers.		Join the upper and lower receivers.	2
18 Push the buffer assembly in about 1/4 inch, press in on the buffer retainer, then release the guide.			
19 Take out the buffer assembly and spring.		Insert the spring and buffer assembly.	1

AND THAT'S AS FAR AS YOU'RE ALLOWED TO GO! **STOP RIGHT HERE!**

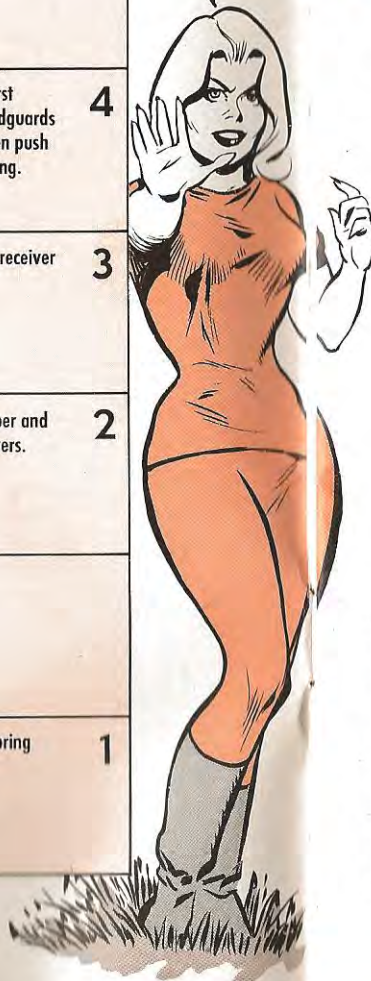

WHAT TO DO IN A JAM

THINK COOL, BUT ACT FAST

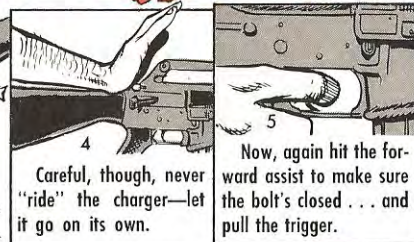

If your M16A1 rifle refuses to pop off—or quits popping sudden-like—you've got a stoppage that needs immediate action.

Immediate Action: Instinctively doing the right thing to clear your weapon and get it firing again, soonest!

Here's a slow motion of the procedure you'd best make second nature:

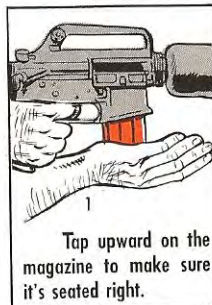

Tap upward on the magazine to make sure it's seated right.

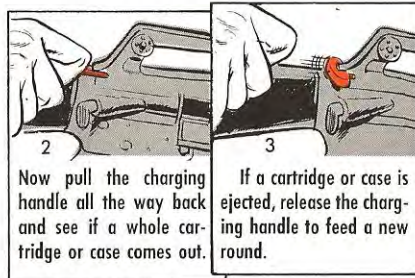

Now pull the charging handle all the way back and see if a whole cartridge or case comes out.

If a cartridge or case is ejected, release the charging handle to feed a new round.



If she won't fire, now look for the cause... a bad round, busted firing pin or hammer spring, or whatever. Table 3-3 in your -12 TM covers causes and cures.



If no cartridge or case ejects, first look for a round in the chamber. If none's there, once more release the charging handle to feed a round. Next hit the forward assist and again pull the trigger.

If she still won't fire, do what your TM says on trouble-shooting.

However, if you do find a cartridge or case in the chamber, be sure you remove it before you try to reload and recycle your weapon.

Now, remember, get these steps down pat.

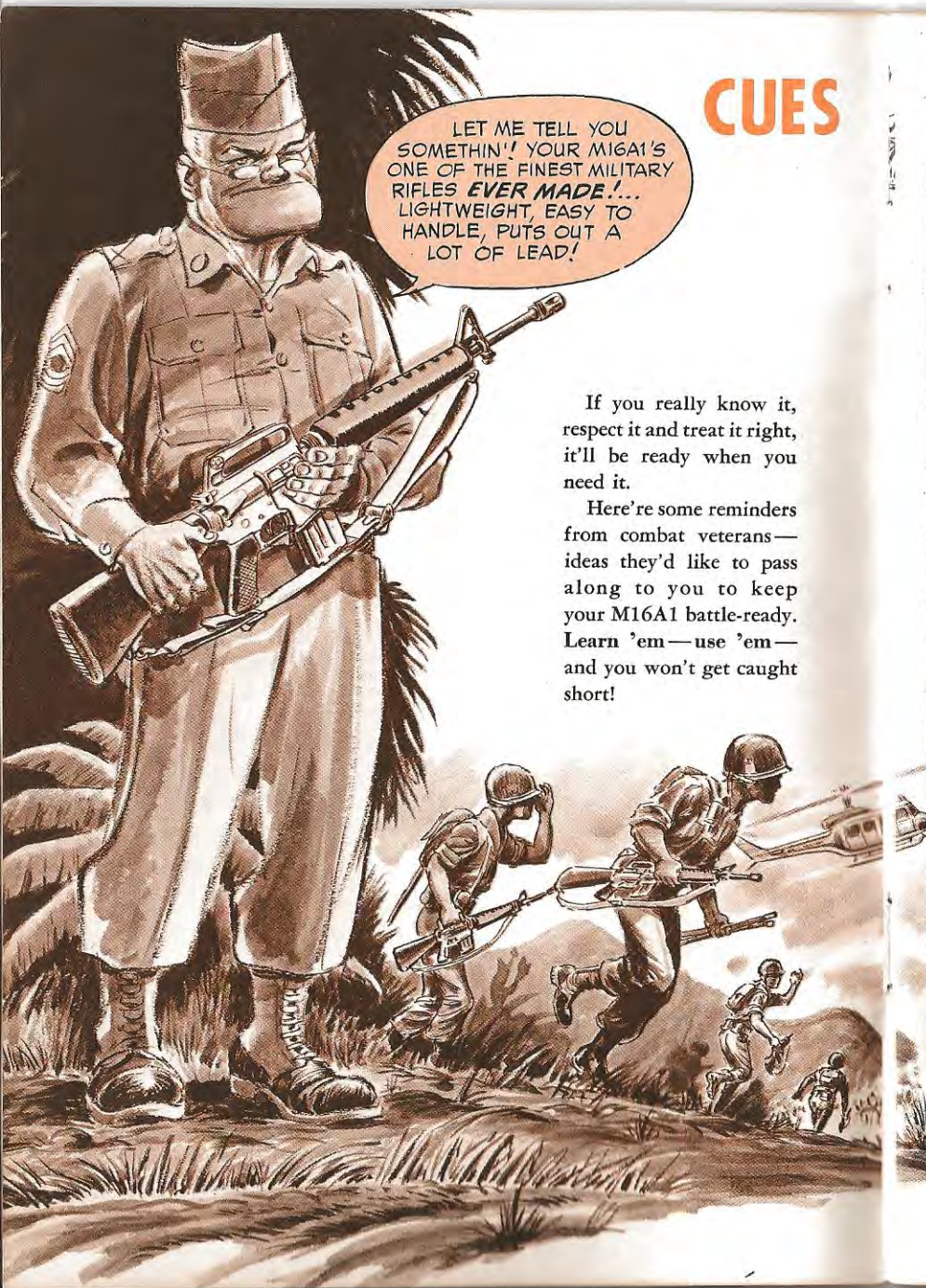

LET ME TELL YOU SOMETHIN'! YOUR M16A1'S ONE OF THE FINEST MILITARY RIFLES **EVER MADE!**... LIGHTWEIGHT, EASY TO HANDLE, PUTS OUT A LOT OF LEAD!

CUES

If you really know it, respect it and treat it right, it'll be ready when you need it.

Here're some reminders from combat veterans— ideas they'd like to pass along to you to keep your M16A1 battle-ready. Learn 'em— use 'em— and you won't get caught short!

FROM GUYS WHO KNOW!

1 Keep your ammo and magazine as clean and dry as possible. The only part of the magazine that gets any lube is the spring — and it gets only a very light touch of LSA. Oil it up and you're headed for trouble.

TOUCH LIGHTLY, PLEASE.



2 Inspect your ammo when you load the magazines. Never load dented or dirty ammo. Remember, Never load over 20 rounds.



3 Clean your rifle every chance you get — 3-5 times a day's not too often in some cases. Cleanliness is a must — and it may save your life!

AH, SWEET 16... AND YOU'VE NEVER MISSED!



4 Be sure to clean carbon and dirt from those barrel locking lugs. Pipe cleaners help here and inside the carrier key.



AND STAY OUT...

5 Never be bashful about asking for cleaning materials when you need 'em. They're available. Get 'em and use 'em!

REMEMBER... THE IMPORTANT THING IS... **KEEP IT CLEAN!**

6 Check your extractor and spring often. If they're worn or burred, get new ones ASAP.



7 Lube your rifle, using LSA only. It's the most. A light coat put on with a rag after cleaning is good. Working parts need generous applications often. The chamber and bore need only a light coat after cleaning.



Worry a little more about your rifle . . . like, baby it a bit. F'rinstance, when you're out in the boonies, be careful where you put it down and how you put it down. Never drop it in mud or water or sand. Just keep in mind that you may have to use it before you get a chance to clean it.

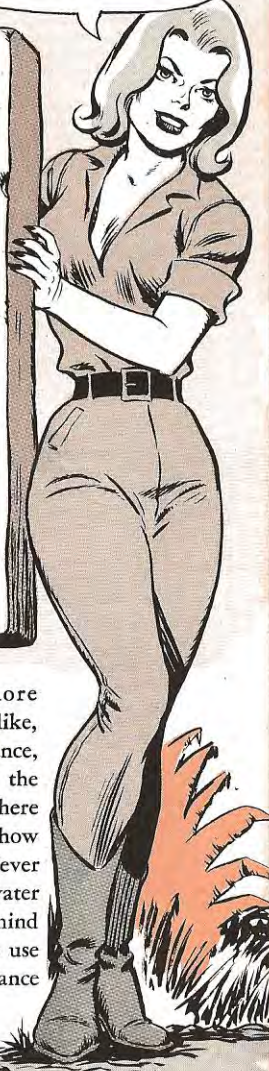

TIPS THAT'LL KEEP
IT YOUR EVER-LOVIN...

SWEET

10



Here're a few cleaning and operating tips that'll help you get best results from your weapon. Some of these tips sort of put the accent on stuff you'll find in the rifle's bible—TM 9-1005-249-12 (1968) with Ch 1. Others are hexes and fixes direct from guys who've been living with this light-weight terror.

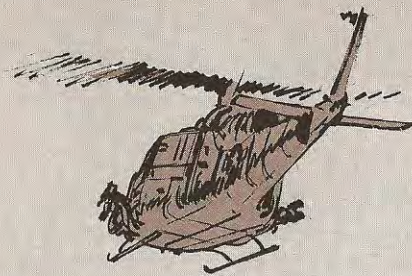

TIP...

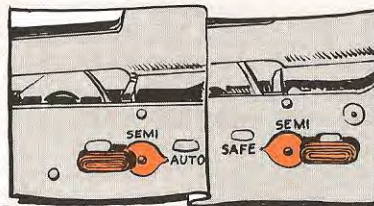

Here's something you want to be real careful about. Don't—like Never!—close the upper and lower receivers while the selector lever's in the AUTO position.

Always—like Always!—point the lever to SAFE or SEMI before closing the receivers.

Here's why: If you jam the receivers closed while the selector's in the AUTO position, you'll force the automatic sear down and damage the automatic sear, and the sear pin, and will likely rough up the bottom of the bolt carrier.

That's 'cause when the selector lever's in the AUTO position, the tang of the automatic sear moves to the rear. You can see how it works by opening the receiver and turning the selector to AUTO and watching the movement of the tang of the automatic sear.

So-o-o . . . do it right . . . every time. Point the arrow to SAFE. Then the receivers will close without any interference.

TIP...

Speaking of magazines . . . every guy has his own idea of how firm or loose he wants the holding action of the magazine catch to be. Which is A-OK as far as it goes. But remember this: The tighter the mag's held in the receiver, the more pressure it takes to release it. And this: The farther the shaft of the catch sticks through the catch button, the tighter the magazine's held in the receiver.

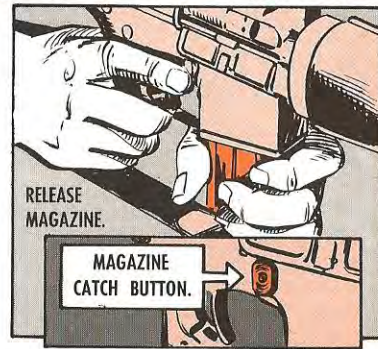

So, take a cue from experience. Adjust the catch button so's it's just about flush with the inner groove or just sticks out a tiny bit. This'll make the catch firm enough to prevent accidentally bumping the button and letting the magazine drop out—yet it won't be so tight that you can't pull the mag out for a quick re-load.

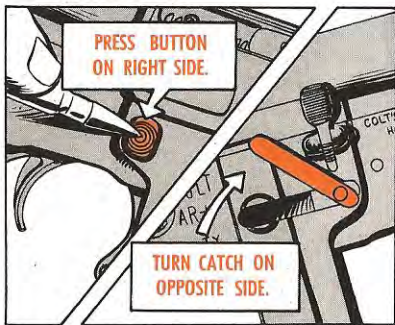

No sweat adjusting the catch the way you want it, either . . . and you're authorized to pull this deal. Just press the button on the right side of the rifle with the nose of a cartridge far enough so's you can turn the catch on the left side of the weapon. You turn the handle clockwise to tighten it and counter-clockwise to loosen it. Best of all, you don't have to take the weapon apart to do this.

TIP ...

You won't have any trouble with the new-type swabs listed in your new TM (FSN 1005-912-4248).

O'course, some guys've been complaining about old-type, big-size cleaning swabs jamming in the bore—and breaking the cleaning rod. You won't have this trouble if you cut 'em all into four equal squares before using 'em. Your bayonet will do the job if you don't happen to have a knife or a pair of scissors handy.

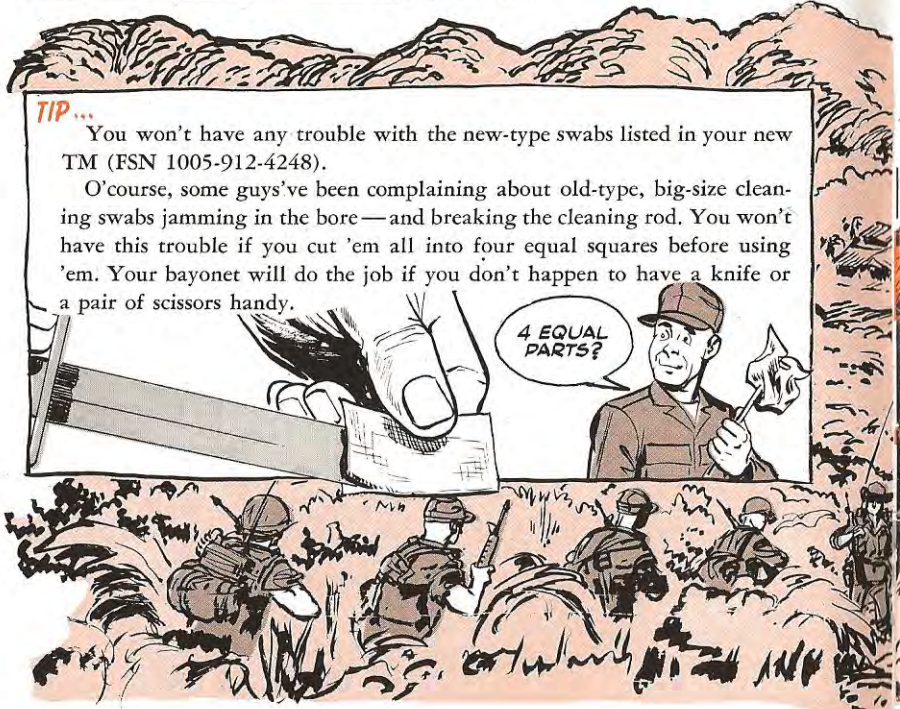

YOUR M16'S MAXI-SKIRT ...

ALL THE WAY WITH NÉGLIGÉ



Now that you've got a plastic coverall bag (FSN 1005-809-2190) to protect your M16A1 rifle against dust, sand, mud, water and such, here's how to use it in good health—yours and your weapon's.

First, make sure your rifle's cleaned and lubed before you bag it. This cover's an aid to PM, but it'll never replace the cleaning and lubing you'll always have to do regularly. In fact, with a rubber band closing—not to mention rips and tears—the bag's not guaranteed watertight, so-oo-o. . . .

Second, if you're gonna keep it bagged more than 24 hours, be sure you eyeball the weapon every day for signs of corrosion from any moisture or condensation that might form in the bag.

Putting it on—Stick the rifle in the cover, muzzle first. Then fold the cover end over the butt stock and slip the rubber band on.



Taking it off—Slip the rubber band off and unfold the cover end. Then slide the rifle out.

Put it on and off gently and you can

use the cover several times.

IN A FIREFIGHT

Comes a sudden opportunity to bag an enemy, here're 2 ways you can work it:

1. Quick-rip the bag off with one steady yank. The bag'll come apart at the tear-line.



2. If absolutely necessary, you can fire right through the bag. You can operate the selector lever and trigger easy with the bag on. But, remember this: Ejected cases will be trapped in the bag and could cause a malfunction after the first round. So get it off as quick as you can.

Natch, after "emergency" use, you'll need a new bag.

TOOLS FOR YOUR M16A1

For Touch-Up Painting
(See Change 1
to your -12 TM)

Solid Film Lubricant...
12-oz spray can
FSN 9150-142-9309

Dichloromethane...
5-gal can
FSN 6810-244-0290

Here's a round-up of the cleaning-lubing equipment you had better use to keep your M16A1 battle-ready. About the only things different are the M11E3 cleaning rod and a PLASTIC BOTTLE for holding your LSA. The big deal is to use this equipment every chance you get.



● Case, Maintenance Equipment
FSN 1005-781-9564

● Cleaning Rod — Any one of these:
M11E1 FSN 1005-903-1295
M11E2 FSN 1005-999-2035
M11E3 FSN 1005-089-3994



● LSA
FSN 9150-935-6597

● 2 oz.
PLASTIC
BOTTLE



● Bore Brush —
FSN 1005-903-1296



● Chamber Brush —
FSN 1005-999-1435



● Pipe Cleaners —
FSN 9920-292-9946

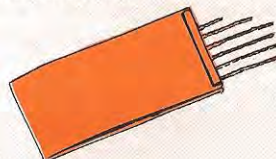

● Cleaning Swab —
FSN 1005-912-4248

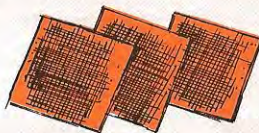

● Bore Cleaner
FSN 6850-224-6656

2 oz.
PLASTIC
BOTTLE



NEW CLEANING ROD

The M11E3 cleaning rod is a 5-piece affair (counting the swab holder as one piece), as compared to 4 pieces for the M11E1 and M11E2. Its over-all length is the same, though. Each section is shorter, that's all.

The threads on the E-3 are the same as on the E-1 and E-2, which means it takes the new bore and chamber brushes.

Don't sweat it, though. The new E-3's probably won't make the rounds till supplies of the E-1's and E-2's are gone.

BWARE: DIFFERENT THREADS

Could be that some time you might have to use other cleaning tools in a pinch. If you do, here's what to look for: Different threads.

Your M16A1's own tools—cleaning rods and brushes alike—all have real fine threads... 36 to the inch.

But, if you're ever in a spot where you have to use any other rod, like the M11 (FSN 1005-070-7812) or any other bore brush like the one that carries FSN 7920-205-2401, or any other chamber brushes, like the M1 (FSN 1005-691-1381) or the M14 (FSN 1005-690-8441), watch this:

Their threads are coarser (32 to the inch). They won't match up with your authorized equipment. Don't try to screw 'em together. Won't work!

No sweat, though, on swabs. If you have the 30-cal type (FSN 1005-288-3565), just cut these big ones into 4 equal parts... and go ahead with your cleaning.

WHY RISK THE DAMAGE?

FIREPOWER

Your M16A1's the spunky teenager of the small arms field, sure, but it's doing a man-size job. So it deserves reasonable treatment—especially in cleaning and lubing its lower receiver area.

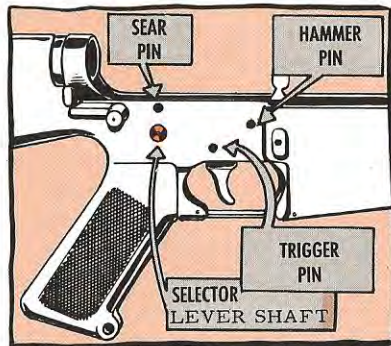

Of course, this all centers on removing or not removing the components of the lower receiver to do the servicing job.

It's a fact. The 5.56-mm rifle doesn't like having its lower receiver taken apart for cleaning—and for good reason.

The lower receiver's made of aluminum to keep the weapon lightweight. But the pins that hold the auto-

matic sear, the hammer assembly, the trigger and the selector lever are all made of steel.

So, if you keep taking the lower receiver apart, these pins'll bye-n-bye make the holes they go through bigger and bigger. First thing you know, the pins fall out and get lost—or the parts they hold won't line up right and your firing's 'way off.

Truth is, you are not authorized to remove the lower receiver's parts at all. You can do a good cleaning job, if you do it this-a-way—and do it every day.

1. Soak your artist brush (FSN 8020-244-0153) or other similar type brush real good with bore cleaner. Then scrub all the parts like there's no tomorrow to get off all the dirt and carbon you can.



2. Tip the lower receiver sideways to drain the excess bore cleaner from the cavity and then wipe it dry.



3. Wrap a piece of clean cloth or cleaning patch around the brush handle and poke it into the hard-to-get-at places. Do the best job you can to get rid of carbon and gunk that could keep the parts from working right.



4. When you're all through—and the lower receiver's dry—put a generous coat of LSA (FSN 9150-935-6597) on all of the insides of the lower receiver and on all of the parts.

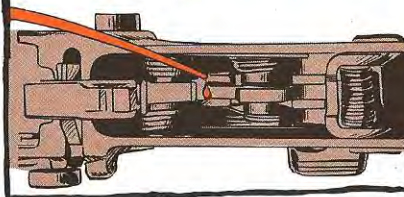

A cleaning job like this will get rid of all the carbon and dirt that might keep your weapon from shooting right. Any stuff that's left after you do your level best won't make no never-mind. Of course, if the lower receiver ever gets so fouled up that the rifle won't fire right, then you let support have a whack at it.

Now you can understand why TM 9-1005-249-12 (1968) with Ch 1, does not authorize disassembly of the

lower receiver group for cleaning by riflemen and armorers. Parts replacement and extra-tough cleaning jobs are for direct or general support only.

But, please don't miss out on that lubing job. All components of the lower receiver—as well as the bolt carrier group—must wear a coat of LSA at all times. No "buts" about it. Your rifle can't perform without it.

That's why "white-glove inspections" are too risky for this baby. There's always the danger that some guy might be tempted to give his weapon a shower or tub bath before inspection to get rid of dirt and lube.



Anybody who bathes his rifle is doing it dirt two ways: First, he's robbing it of the lube protection it needs. Second, he's liable to let water seep into the lower receiver extension. This could cause corrosion of the extension and rusting of the action spring—or it might result in a short recoil of the bolt carrier group, thereby preventing the bolt assembly from retracting far enough to strip a cartridge from the magazine.

When you consider that all this has a direct bearing on how well your M16A1's going to fire and protect your hide in a showdown, these angles make real good sense, don't they?

MORE POINTERS TO PONDER

FOR YOU M16A1 ZAPSTERS!!
HERE ARE SOME NUMBAH ONE PM SUGGESTIONS TO KEEP YOU GO-GO!

HOW TO FIGHT CARBON FREEZE ...

KEEPING A HEALTHY BOLT ...

Another thing: When you're crawling or walking through the brush, make a mental note to make sure you don't get the flash suppressor caught in a bush. It catches easy, y'know.

All the way ... Educate your sixth sense to flip the selector lever all the way across to get from Safe to Automatic. In an ambush situation, you just might flip it only halfway — to Semiautomatic — when you'll need all the fire you can get.

You might practice flipping it all the way till this becomes second nature.

All in all, this M16A1's a real sweet number. It'll stay that way as long as you treat it like one.

Combat types can't emphasize this enough: Clean the gas port in the bolt carrier group every day — and take it real easy with the lube. Dirt and powder-fouling — plus an overdose of lube oil — will give you a sluggish rifle. . . . Numbah 10 'Thou' in a combat situation!

So, when you get your baby stripped for cleaning, like it says in para 3-9 in TM 9-1005-249-12 (1968) with Ch 1, take an extra 5 seconds to get at the port hole down there in the front end of the gas tube. Like so:

1. Work a worn bore brush full of bore cleaner around inside the key.

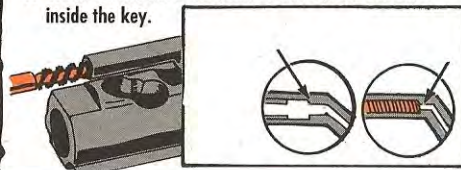

Make sure you get the metal end of the brush in all the way — right into the bottom of the hole where the gas tube is seated in the carrier key — and then turn it to loosen the crud. That last $\frac{1}{16}$ -in in there is the most neglected part on most M16A1 rifles.

2. Then use a pipe cleaner or the like to poke the gook out of the port. Don't use wire, though, or you might scratch the tube and set up worse trouble later on.

FSN 9920-292-9946
PIPE CLEANER

NOW IN YOUR TM

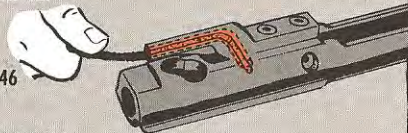

3. Use another pipe cleaner — or air-dry it by waving it around — to dry the tube as well as you can.

4. Now doublecheck your job. Remove the bolt. Then stick the carrier body into the receiver slide-way and push the carrier back and forth slowly to check that the carrier key and gas tube line up OK. The carrier should move freely . . . and should go all the way without friction. If it won't go all the way without a struggle, you've got some more cleaning to do. But, if it binds, turn the weapon in for repair.

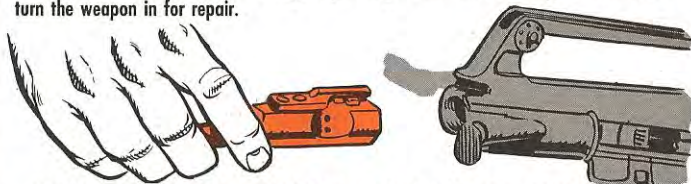

Here's the Pitch: The front end of the gas tube is self-cleaning, thanks to the hot gases and high pressure from the barrel. But, if you don't keep the other end clean — the gas tube area where it mates with the carrier key inside the receiver — brother! You've got to clean this area with elbow grease to prevent stoppages. Hear!

Now, when you come to lube-preserving, stick to the dope in the lube guide pages 22-24 of this pamphlet.



TIP . . .

Another couple places you won't want to forget when you're cleaning your weapon are the claw under the extractor in the bolt group and the locking lug recesses on the barrel extension in the upper receiver. If dirt and crud



collect under the extractor, the claw won't be able to snap over the rim of a cartridge case. And if gunk and brass chips from cases gather in the recesses, your bolt action will be stymied. So, bear down on your bore brush in both these places.

TIP . . . While you have the bolt group apart—and after you clean 'em—make a practice of eye-checking these parts:

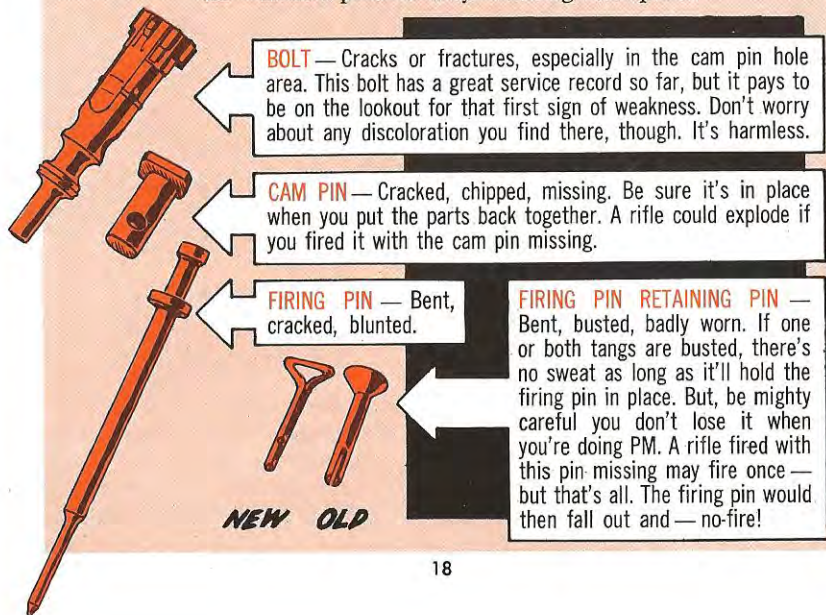

CLEAN . . . INSPECT . . . REPLACE

PARTS AS NEEDED

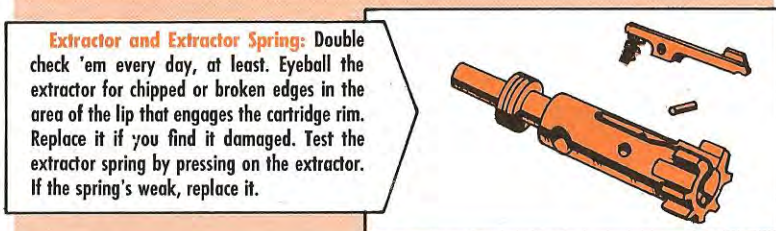
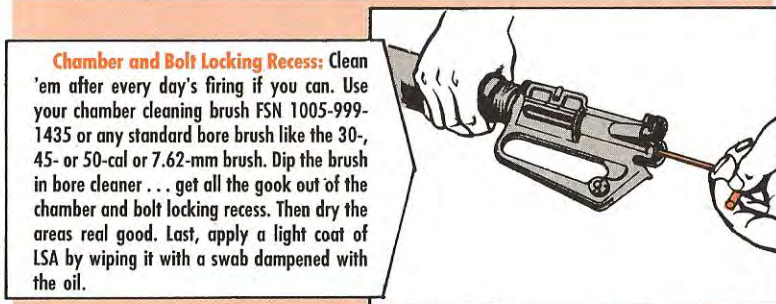

REMEMBER—Watch your lubing. Too much lube speeds carbon buildup in the chamber and bolt locking recess. Same thing with the carrier key. A rag or swab or even a pipe cleaner dampened with LSA will do the trick here. Best bet: Follow the guide on pages 22-24.

M16A1 RIFLEMEN ...
WHEN THE BASES ARE LOADED ...

EVERY HIT COUNTS



Here're some coaching hints for a better season with your M16A1 rifle in the Vietnam League.

LAID A BUNT LATELY?

Probably not. But you could use the same idea when you're bore-brushing your weapon. Right. Choke up on the cleaning rod—hold it about 2 inches from the receiver and push it straight inch by inch in short jerks all the way through the flash suppressor. Then pull it back all the way out—again in short jerks. Never pull the brush back till after it's gone through the flash suppressor. Do it the right way and you won't hurt the rod.

Same idea goes when you're running patches through. Run it all the way through the flash suppressor before you start to pull back . . . no matter what size patches you're using—the one for the M16A1 (FSN 1005-912-4248) or any large type that you have to cut into 4 equal squares.

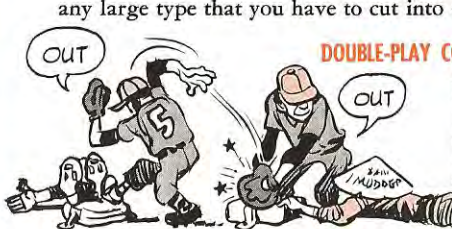

DOUBLE-PLAY COMBINATION

By the way, when was the last time your unit armorer—Max Schnell, good 'ol Speedy Four—checked out your weapon? Don't know? Can't remember? Then it's due right now for a physical. Get with it! Maxie's the best partner you'll ever have . . . PM-wise.

Here're a couple ways Maxie can shortstop trouble for you:

Any time you run into real trouble

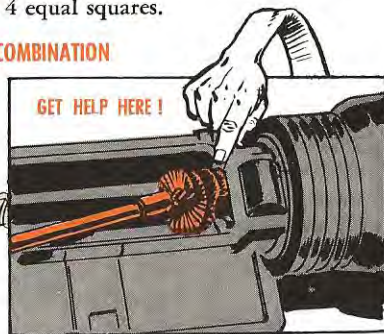

with crud or carbon buildup when you're cleaning your rifle—especially in the bolt and locking recess area—get your armorer to help you tackle it with P-C-111 carbon removing compound, FSN 6850-965-2332, 5-gal pail.

COVER YOUR CORNER ONLY

Some guys really spoil a play by reaching out for balls not meant for 'em. Bumped heads and lost games result.



Ditto for all parts of the upper receiver assembly. If any part gets bent—like the ears around the rear sight—or any part comes loose or busted, f'goshsakes, don't you try to fix it—nor you, either, Maxie! Turn the weapon in to DS.

And still one more: Natch, when you're field stripping your rifle you'll be careful not to drop the carrier and key assembly or bump 'em against anything hard. The carrier key bends pretty easy—and then won't line up inside the weapon. But, if they do get bent, don't you or your armorer try to straighten 'em. That's a drive too hot to handle. Let DS fix 'em.

You're bound to have a good season if you stay on the ball with your PM.

WATCH YOUR BUTT, TOO!

While we're gabbing about water, let's hammer home the importance of keeping it out of the lower receiver, too. This may not have anything directly to do with blowing up your shooter, but it could keep it from firing—which is the next worst thing.

Right, every time you clean your M16—and every time you drain water from the bore—take an extra second to make sure the drain hole in the butt stock capscrew is open . . . and drain the butt, too.

A pipe cleaner's about the handiest thing for keeping this hole clear.

If water stays in the lower receiver,



it'll foul up the working parts . . . cause corrosion and dampen your ammo.

So, remember, huh?

All of this boils down to one thing, then: Your Prevention is the cure.

Here're a couple-three lube tips that'll help you and your armorer get the most out of using LSA (Lube Oil, Semi-fluid, Automatic Weapons, MIL-L-46000A) on your 5.56-MM rifle — now that it's LSA all the way for the M16A1 zap-machine anywhere but in real cold-weather areas.

Yessir, LSA's here to stay. It does a better lubing job on working parts, especially in a muggy-wet climate like Vietnam's . . . it lasts longer . . . it really protects metal surfaces. Here're the stock numbers that'll fetch it for you: FSN 9150-935-6597—2-oz LSA tube; FSN 9150-889-3522—4-oz tube; FSN 9150-687-4241—1-qt can; FSN 9150-753-4686—1-gal can.

WHERE AND HOW MUCH LSA?

The big trick to using LSA is to get plenty of it on the working parts—like those inside the upper and lower receivers—and very light doses in other places—like the bore and chamber, inside the carrier key, inside the bolt and on the firing pin and the magazine spring—and none at all on your ammo or on the inside of your magazine.

CLEANING—Normally, you want your rifle spitting clean inside and out before you apply LSA. So do a real good job after every firing mission, following the good word in your TM by using rifle bore cleaner (CR).

Too busy fighting? OK, then postpone the cleaning **BUT** lube all the working parts with LSA frequently and generously.

Be sure you keep that drainage hole in the butt cap screw unlogged at all times. A pipe cleaner or rice straw works fine for this.

LUBE THESE PARTS **GENEROUSLY!** AND FREQUENTLY WITH LSA!



INSIDE PARTS UPPER RECEIVER

GENEROUSLY HERE ON OUTSIDE



BOLT CARRIER GROUP PARTS

BUT LIGHTLY HERE:



AND IN FIRING PIN WELL



INSIDE PARTS LOWER RECEIVER

FRONT SIGHT POST
FRONT SIGHT DETENT SPRING

LSA LUBE GUIDE

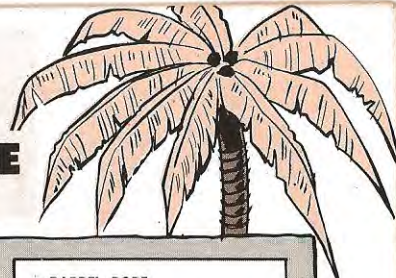

THESE PARTS GET LUBED **LIGHTLY.** USE A PATCH DAMPENED WITH LSA.

BARREL BORE START AT RECEIVER



GO RIGHT THRU THE SUPPRESSOR

CHAMBER



BE SURE YOU COAT LOCKING LUGS

ALL EXTERIOR METAL SURFACES INCLUDING THOSE UNDER THE HANDGUARDS



BUFFER



BUFFER SPRING

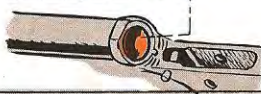

INSIDE LOWER RECEIVER EXTENSION



MAGAZINE SPRING

YOUR ARMORER WILL LUBE THESE PARTS GENEROUSLY WITH LSA!

YOUR ARMORER'S AREAS

SELECTOR LEVER DETENT AND SPRING

LOWER RECEIVER EXTENSION

SAFETY DETENT

SAFETY SPRING

TAKE DOWN PIN

SPRING

DETENT

GET PLENTY OF LSA ON THE OUTSIDE SURFACE OF THE LOWER EXTENSION TO PREVENT CORROSION.

PIVOT PIN

DETENT

SPRING



MORE LUBE TIPS

Say... having trouble with how much LSA it takes for a "GENEROUS" application?

Or what constitutes "LIGHTLY" lubricated?

Well, don't get excited. The terms are only general and are not intended to designate a precise amount of lubrication.

Consider it generously lubed if the part is covered with enough LSA that you can see an obvious film heavy enough you can wipe around with your finger (you don't have to squirt her full).

If you have wiped on a coat of lubricant with a rag or swab moistened with LSA, but it's still not so much you can really see a film on the part, call it "LIGHTLY" lubed.

ZAPPER'S OWN M16 PUB

Hey, you M16A1 sharpshooters, be sure you latch on to TM 9-1005-249-12 (1968) with Ch 1. That's right -- "-12." It replaces all the operator-organizational dope in the -14 TM with all of its changes.

M16A1 SHARPSHOOTERS,
MAKE THIS YOUR SOP...

DRAIN BEFORE SHOOTING



Yep, "fighting's" the word.

You only use these new plastic protective caps (FSN 5340-880-7666) when you're in action... not when your shooter's put up for a day or more. Else condensation'll build up and ruin the bore.

The cap'll keep out rain, dust and dirt, but it won't keep water from seeping into the bore from the chamber end when your rifle gets dunked. This water's got to be removed before you try to fire.

HERE'S WHAT YOU DO!... AFTER YOU REMOVE THE CAP.

POINT THE MUZZLE DOWN...

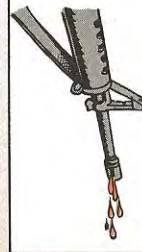

CHARGING HANDLE SLIGHTLY REARWARD!

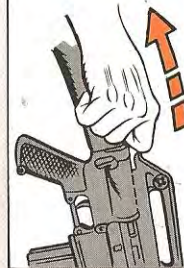

PRESS FORWARD ASSIST TO SEAT ROUND



So get with that routine in para 2-11 to your new -12 TM before you fire off.

THIS CAP WON'T EXCUSE YOU FROM DAILY (OR OFTENER) CLEANING AND LUBING



M16A1 RIFLEMAN:
TRY OGLING THESE...



MAGAZINE PINUPS!



From 17 to 20's fine, but 21's too many when you're loading cartridges in the magazine of your M16A1 rifle. It won't give you extra fighting power . . . more likely it'll put you out of the fight—'cause that extra round will spread the lips and the ammo won't feed right.

When unloading, never flip the rounds out with another cartridge. You'll spread the lips this way, too. Instead, slide the rounds out straight ahead . . . like they go into the chamber.

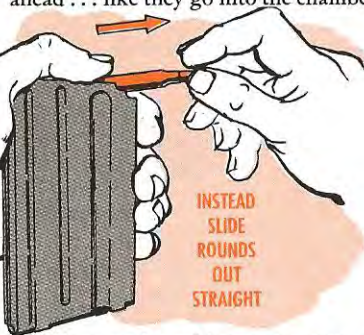

When you're taking your magazine apart here's as far as you can go. Any further and you might damage it.

1. Stick cartridge point in here to press the floor plate release.
2. Slide out the floor plate.
3. Work the spring back and forth gently as you tug it outward.
4. Stop tugging when the follower reaches the tabs and ears and don't separate the spring from the follower.

Careful . . . you don't stretch or bend the spring and don't bend the tabs. Easy does it all the way.

For cleaning the disassembled mag—Either dunk it in rifle bore cleaner and shake it good while submerged

OR—scrub the inside with a brush soaked with cleaner

OR—Use a rag soaked in bore cleaner.

Then dry it out good with a swab or rag (or even your shirttail in a pinch).

After you clean the inside of the magazine, wipe the spring off and see that it's not busted or deformed. If it's OK, apply a very-very-very light coat of lube—using a rag dampened with LSA.

This mag is coated with dry lubricant. It doesn't need any lubing except for the spring.

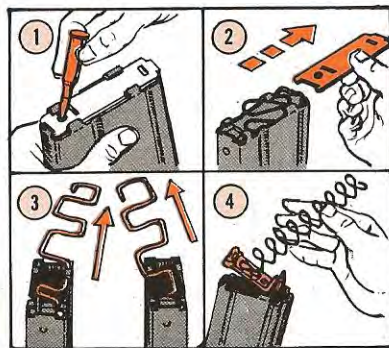

PUTTING MAGGIE TOGETHER

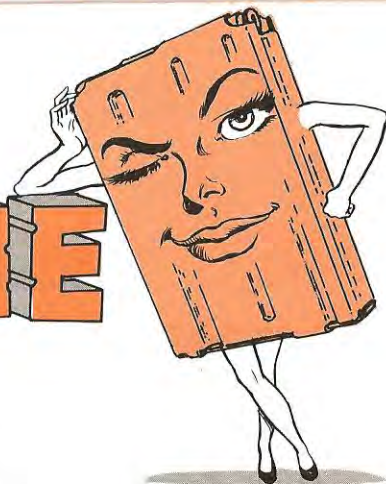

Here's the easy way . . . gently:

1. Nose the bullet end of the follower into the body at a 45-degree angle till it touches the inside edge of the body.

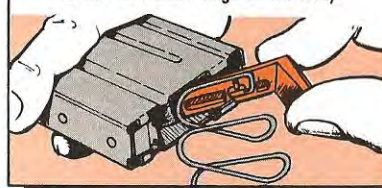

2. Work the other end of the follower into the body.

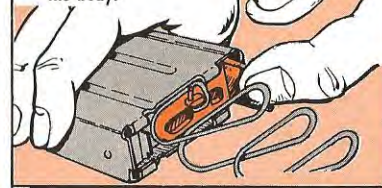

3. Just wiggle the spring into the mag as far as it'll go.

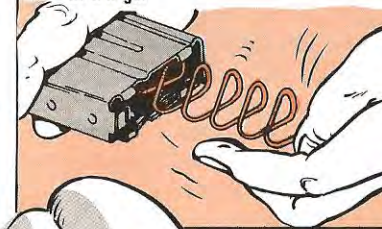

4. Make sure the printing on the floor plate is on the outside. Slide the plate in this way, then press the spring down with your thumb. And make sure the floor plate goes under all 4 tabs, too.



HERE'S AN IMPORTANT **TIP**:
IF THE SPRING SHOULD ACCIDENTALLY GET SEPARATED FROM THE FOLLOWER, TURN THE MAGAZINE OVER TO YOUR ARMORER! **DON'T** TRY TO FIX IT YOURSELF. LOOKS EASY, SURE, BUT WITHOUT THE RIGHT TOOL YOU'D DAMAGE THE SPRING... AND END UP WITH FEEDING TROUBLE.

PROTECTING YOUR MAG



PROTECT ME,
YOU BIG STRONG
GUY!

Not easy, that's for sure, when you're wading streams and rice paddies or in heavy rainfall. Normally clean water itself is not harmful. Brackish water—that's another story. But the real harm comes when you don't do anything about it after your stuff gets wet.

Here're some ideas that might help:

1 When fording, try to keep your mags out of the water. This means holding your rifle 'way up there and, if you can, keep the pouch with the spares above the water line.



2 Soon as you come out of the drink—if Charlie's not interfering, natch—take the mags out and shake 'em good a couple of times to get rid of most of the water.



3 Then at the first breather—when you're sure Charlie's not around—empty each magazine, wipe it dry inside and out with your shirttail or swab and then clean both the ammo and the magazine.

TIP: You M16A1 zapmen using a plastic bag (FSN 1005-052-6942) to protect your loaded magazine, use your head. The bag's apt to collect condensation if it's wet or humid, so, check your bagged magazine daily. If you see beads of condensation inside the bag, take off the bag and dry it, the magazine and the ammo thoroughly—and don't forget that little film of LSA on the magazine spring. This bag, y'know, won't excuse you from regular PM chores.



F'goshsakes, never put oil of any kind—including LSA—on the cartridges or inside your magazine! Lube ruins ammo and collects gook—could leave you helpless in a fight! This mag is coated with dry lubricant. It doesn't need any lubing except for the spring—and that only very lightly, with LSA.

Take care of your magazines— and hang on to 'em. Sure, there're plenty of 'em in supply—world-wide—but they could get mighty scarce in your own sector. So, protect 'em from dents (aluminum can't take rough treatment)—and especially, remember to bring those "empties" back. The one you save just might save you some day.



VEHICLE RIFLE HOLDERS

No matter what size truck you pilot where the action is -- any where from a 1/4-ton M151 to a 10-ton M123 -- make sure it's equipped with a bracket to hold your (and your side-kick's) M16A1 or M14 rifles.

If you jockey one of those new 1-1/4-ton M715's or M725's, no sweat. They come equipped with a single rifle bracket mounted on the left side of the panel behind the driver's seat.

But, on all other trucks, you install a pair of brackets right up front. The M151 gets one to the left of the driver and the other to the right of the passenger. The others get 2 located just to the right of the driver.

Anyway, the item you want goes by the moniker: KIT, MOUNTING, RIFLE BRACKET, and answers to FSN 2590-045-9611. The bracket will handle either the M16A1 or the M14, though you may have to do a little maneuvering to get the M16 to fit the way you want it.

Here's where to look for installation and parts poop for the various vehicles:

TB 9-2300-209-20 (6 Feb 67) for 3/4-, 2-1/2-, 5- and 10-ton trucks.

TM 9-2320-218-20 (Apr 63) with Change 2 (16 Nov 65) for the M151 1/4-tonners.

5.56-MM SUBMACHINE GUN, XM177E2:

So you've got the new XM-177E1 or XM177E2 5.56-MM Submachine Gun —or you're expecting it on the next chopper!

HERE
COMES
SHORTY!



So, here's the Numbuh One poop on it:

It needs exactly the same tender loving care and cleaning as the M16A1 rifle. Give out with this TLC and you'll escape the woes some Joes had because they skimped PM on their Sweet 16's.

Yeah, this Shorty's pretty much like the M16A1—it's just shorter in the barrel and hand guards, has an adjustable butt stock and a combination noise and flash suppressor. Most of its other parts are common to the M16A1.

All cleaning and lubing requirements are the same, too—and if you don't do 'em Shorty'll act up. Even the cleaning tools are the same.

You'll find all the parts common to the Shorty in POMM 9-1005-294-14.

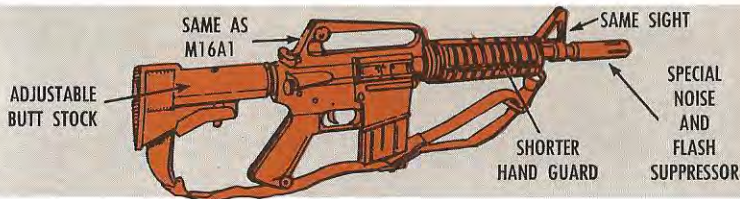

HERE ARE THE PARTS FOR SHORTY-



- | | | |
|--|---|--|
| ① NUT, LOCK PIN
FSN 5310-917-1215
(62368) | ③ PIN, LOCK
FSN 1005-914-3229
(62361) | ⑤ STOCK, BUTT, SLIDING
FSN 1005-914-2943
(62359) |
| ② LEVER, RELEASE
FSN 1005-914-3224
(62360) | ④ SPRING, LOCKING
FSN 1005-916-9178
(62369) | ⑥ BUFFER ASSEMBLY
FSN 1005-914-4578
(62382) |

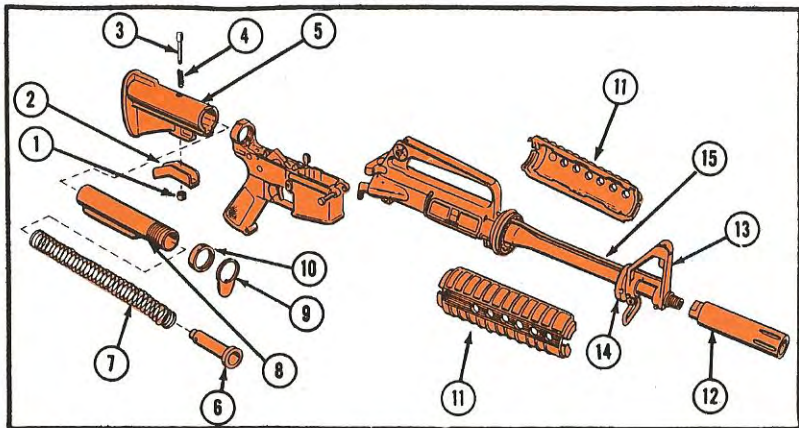

- | | | |
|--|--|--|
| ⑦ SPRING, ACTION
FSN 1005-914-4564
(62373) | ⑩ NUT, RECEIVER EXTENSION
FSN 5310-917-1153
(62357) | ⑬ BARREL AND
SIGHT ASSEMBLY
FSN 1005-914-4567
(62378) |
| ⑧ EXTENSION, LOWER
RECEIVER
FSN 1005-914-2929
(62356) | ⑪ HANDGUARD ASSEMBLY
FSN 1005-914-4572
(62381) | ⑭ CAP, HANDGUARD
FSN 1005-914-2922
(62346) |
| ⑨ PLATE, END
RECEIVER
FSN 1005-914-2942
(62358) | ⑫ SUPPRESSOR,
NOISE AND FLASH
FSN 1005-914-3902
(62370) | ⑮ TUBE, GAS ASSEMBLY
FSN 1005-914-3504
(62366) |

HEADQUARTERS
DEPARTMENT OF THE ARMY
WASHINGTON, D. C., 1 July 1969

The proponent agency of this pamphlet is the U. S. Army Materiel Command. Users are invited to send comments and suggested improvements on DA Form 2028 (Recommended Changes to Publications) to the Commanding General, U. S. Army Weapons Command, ATTN: AMSWE-SMM, Rock Island, Illinois 61201.

By Order of the Secretary of the Army:

Official:
KENNETH G. WICKHAM,
Major General, United States Army,
The Adjutant General.

W. C. WESTMORELAND,
General, United States Army,
Chief of Staff.

Distribution:
To be distributed in accordance with DA Form 12-11, requirements for Rifle, 5.56MM, XM16E1.